

Technical Information — Sizes

T-Molding

T-Moldings are commonly used in doorways to join two laminate floors in adjoining rooms. Also recommended when making a transition from laminate floor to another floor that is approximately the same height. **Available as Standard or Moisture Resistant.**

Surface Material: High Wear Resistant Aluminum Oxide Laminate

Core Material:

Standard T-Molding: Moisture Resistant MDF

Moisture Resistant T-Molding: Exterior Grade Composite Wood Product

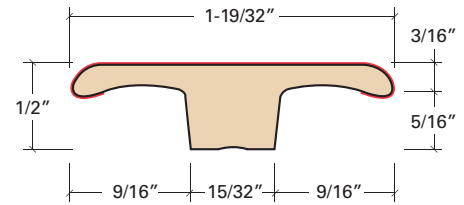

Versatrack Shim

To be used with T-Molding, Reducer and End Cap in conjunction with the Versatrack (metal) for floors from 9.5mm-12.3mm thickness including 3/32nd underlayment.

Material: Standard HDF

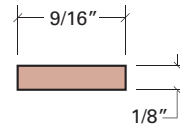

Versatrack

To be used with T-Molding, Reducer and End Cap for floors from 6mm-9.5mm thickness including 3/32nd underlayment. Also, used in conjunction with the Versatrack Shim for 9.5mm-12.3mm* including 3/32nd underlayment.

Material: Cold Roll Steel

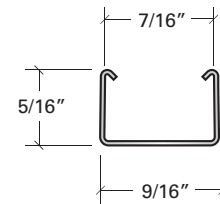

* For floors thicker than 12.3mm, please feel free to call one of our sales representatives for assistance.

Installation*

8 mm Floors**

Glue Down for 8 mm floors.

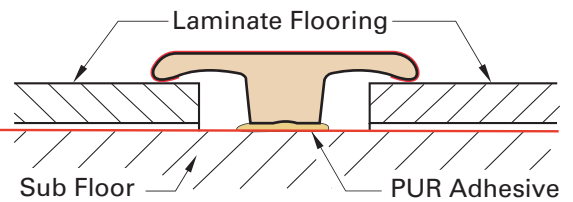

9-12 mm Floors***

Use Versatrack (Metal Track) for 9-12 mm floors.

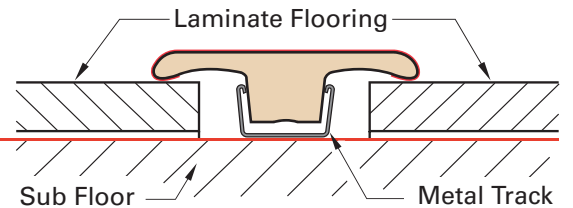

12-15 mm Floors***

Use Versatrack & Versatrack Shim for 12-15 mm floors.
Use the same molding & track, just add 1 Versatrack Shim.

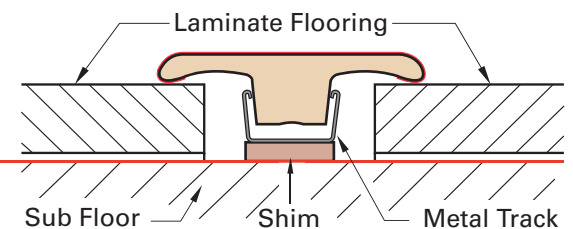

15-18 mm Floors***

Use Versatrack & Versatrack Shims for 15-18mm floors.
Use the same molding & track, just add 2 Versatrack Shims.

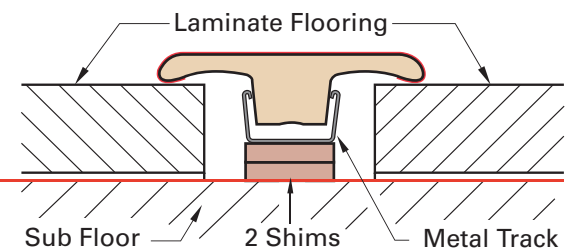

*The installation instructions shown on this page are suggestions of how to install our moldings. Versatrim does not assume responsibility for any product failure or liability due to installations that are in violation of the flooring manufacturer's installation guidelines and/or warranties.

**All references to flooring thickness refer to the total thickness of all members of the floor installation being laid upon the subfloor. This typically is comprised of the flooring plank, e.g. Vinyl or Laminate, the underlayment, either attached or loose lay and any additional vapor barriers.

T-Molding

Use Versatrack (Metal Track) for 9-12 mm floors.

9-12 mm Floors

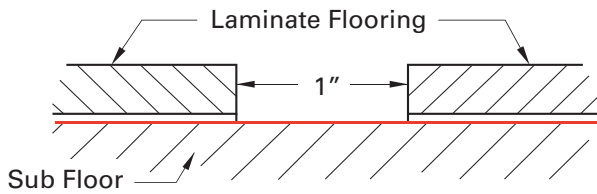

Step 1

Install the flooring planks including the underlayment by leaving a 1" inch (25mm) gap for the installation of the T-molding.

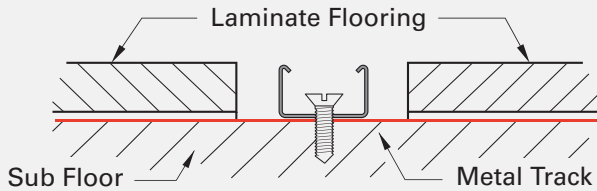

Step 2

Center the U-Track between the two laminate floors and screw it to the sub floor by using #6 screws.

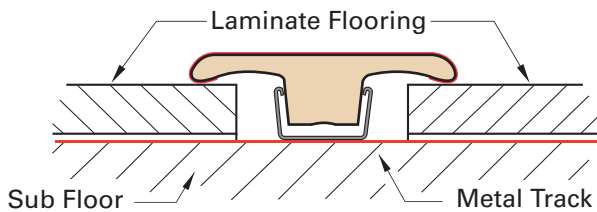

Step 3

Gently press the molding into the track starting from one end to the other just like you would close a Zip-Lock bag.

!!! Do not try to push the entire molding in all at once by just pressing it in from top !!!

Use Versatrack & Versatrack Shim for 12-15 mm floors.
Use the same molding & track, just add Versatrack Shim.

12-15 mm Floors

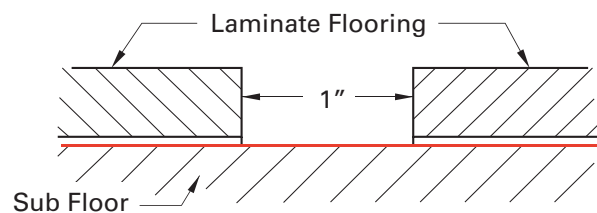
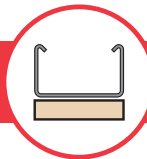

Step 1

Install the flooring planks including the underlayment by leaving a 1" inch (25mm) gap for the installation of the T-molding.

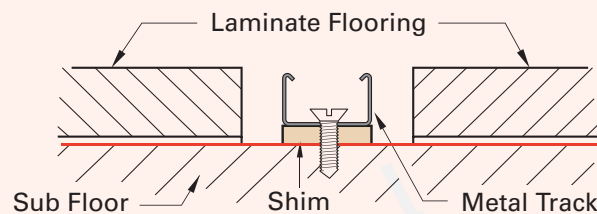

Step 2

Center the U-Track and Shim between the two laminate floors and screw them to the sub floor by using #6 screws.

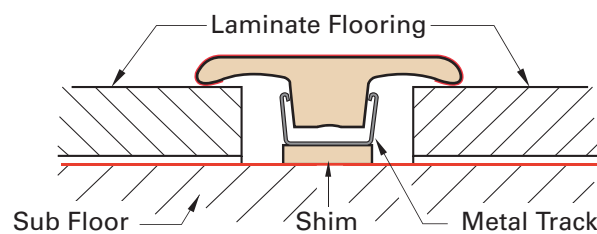

Step 3

Gently press the molding into the track starting from one end to the other just like you would close a Zip-Lock bag.

!!! Do not try to push the entire molding in all at once by just pressing it in from top !!!

T-Molding

Use Versatrack & Versatrack Shim for 15-18 mm floors.
Use the same molding & track, just add Versatrack Shim.

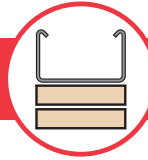

15-18 mm Floors

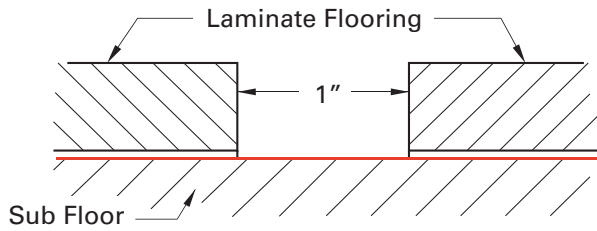
**Step 1**

Install the flooring planks including the underlayment by leaving a 1" inch (25mm) gap for the installation of the T-molding.

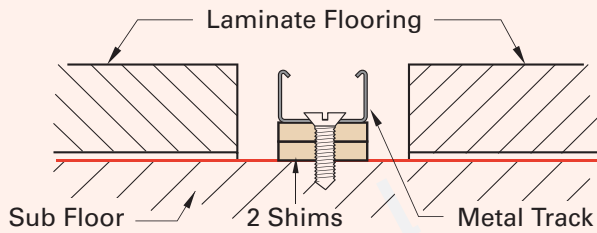
**Step 2**

Center the U-Track & 2 Shims between the 2 laminate floors and screw them to the sub floor by using #6 screws.

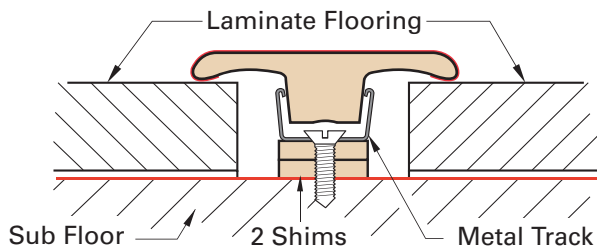
**Step 3**

Gently press the molding into the track starting from one end to the other just like you would close a Zip-Lock bag.
!!! Do not try to push the entire molding in all at once by just pressing it in from top !!!

T-Molding - Glue Down on Subfloor or Concrete



Glue Down - 8 mm floors

8 mm Floors

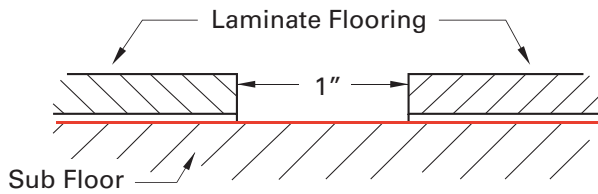

Step 1

Install the flooring planks including the underlayment by leaving a 1" inch (25mm) gap for the installation of the T-molding.

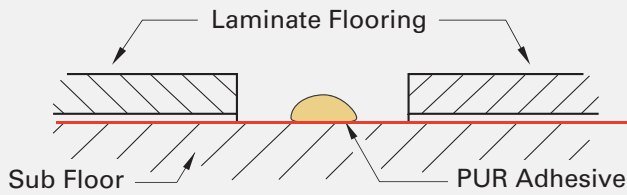

Step 2

Run a bead of PUR adhesive between the two planks

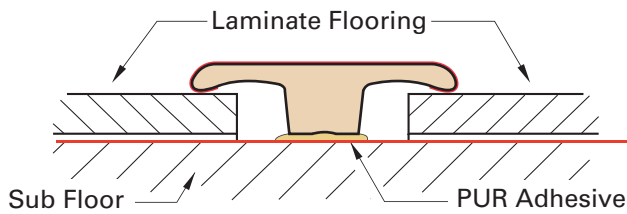

Step 3

Gently press the molding into the adhesive and adjust to make sure it is straight.

T-Molding

Use the black Thin-Track for 7 - 9.5 mm floors.

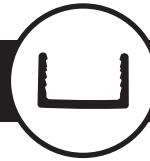

7 - 9.5 mm Floors

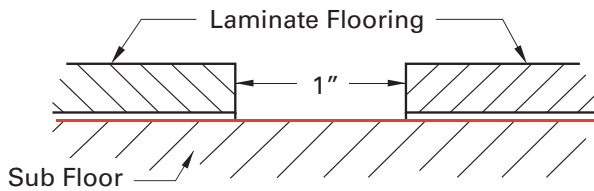

Step 1

Install the flooring planks including the underlayment by leaving a 1" inch (25mm) gap for the installation of the T-molding.

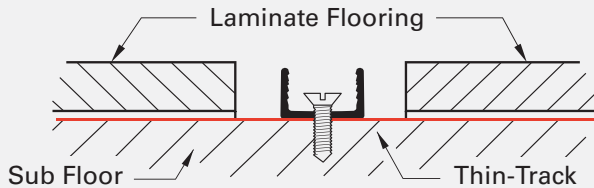

Step 2

Center the U-Track between the two laminate floors and screw it to the sub floor by using #4 screws.

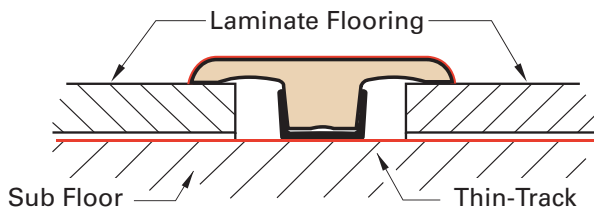

Step 3

Gently press the molding into the track starting from one end to the other just like you would close a Zip-Lock bag.

!!! Do not try to push the entire molding in all at once by just pressing it in from top !!!

Use the white Thick-Track for 9.5 - 12.3 mm floors.
Use the same molding, it is just a different track.

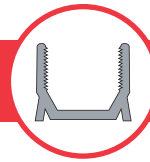

9.5 - 12.3 mm Floors

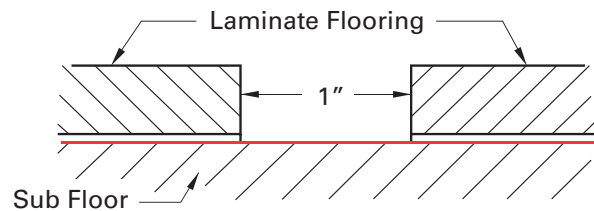

Step 1

Install the flooring planks including the underlayment by leaving a 1" inch (25mm) gap for the installation of the T-molding.

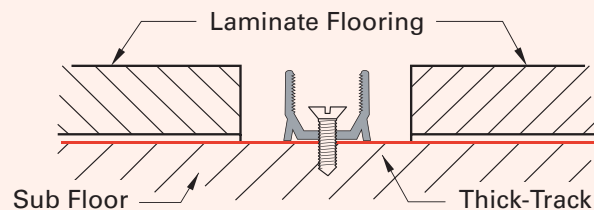

Step 2

Center the U-Track between the two laminate floors and screw it to the sub floor by using #4 screws.

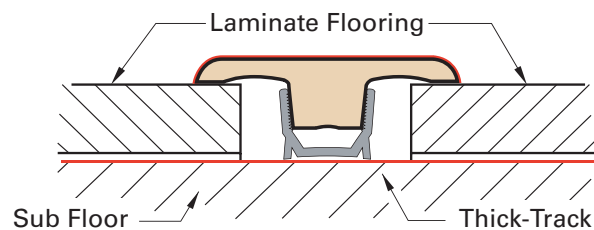

Step 3

Gently press the molding into the track starting from one end to the other just like you would close a Zip-Lock bag.

!!! Do not try to push the entire molding in all at once by just pressing it in from top !!!

T-Molding - CONCRETE Install

Use Versatrack (Metal Track) for 6 - 12.3 mm floors.

9-12 mm Floors

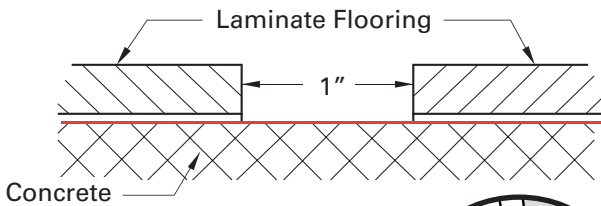

Step 1

Install the flooring planks including the underlayment by leaving a 1" inch (25mm) gap for the installation of the T-Molding.

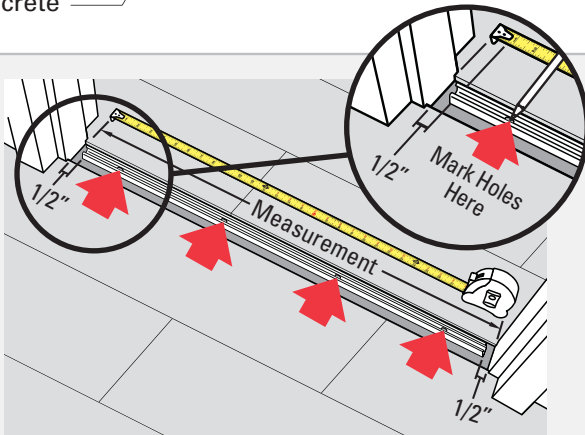

Step 2

Measure the door frame to determine width. Cut the Versatrack to the appropriate size of the door opening, leave a 1/2" gap on each side. Lay the Versatrack in the position to be installed, and mark each of the holes with a marker/pencil on the concrete floor. Make sure that the track does not shift while marking each hole.

General Disclaimer: Never drill into a slab that has radiant heating installed. Be aware of potential gas, electrical, water or low voltage lines present in the slab before starting your project. If unsure about these circumstances, we strongly recommend to use a glue down installation instead (See Page 4). The glue down option would require a high quality construction adhesive.

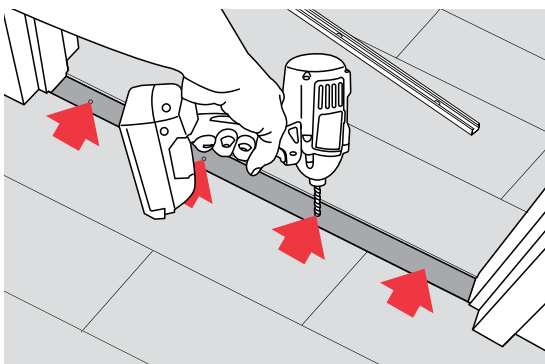

Step 3

Lay the track aside, and drill into the concrete floor by means of a 1/4" masonry drill bit. Make sure the drill does not 'dance' off the mark when starting to drill, as it will otherwise bend the track when affixing to the floor. Drill only as deep as your selection of dowel/screw combo requires. Never drill deeper than 1-1/2" into the concrete!

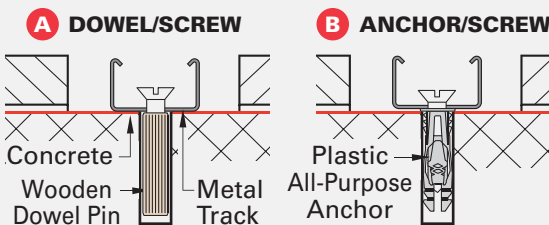

Step 4 - Use your preferred method of screw dowel combo:

A - Screw + 0.375 x 1.25" Wooden Dowel Pin: With #6 x 1" screws, this option will give you a little bit more flexibility in case the drill holes are not 100% in line with the track holes. Make sure you drive the wooden dowel flush with the concrete, if it sits a bit high, scrape it flush with a chisel!

B - Screw + Plastic All-Purpose Anchor: Start all screws in each hole before you tighten one all the way down. This will ensure that all holes line up properly with the track.

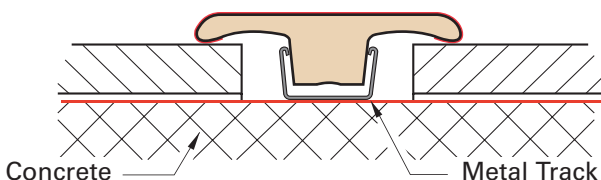

Step 5

Gently press the molding into the track starting from one end to the other just like you would close a Zip-Lock bag.

!!! Do not try to push the entire molding in all at once by just pressing it in from top !!!